

CDEX-1 1 kg point-contact germanium detector for low mass dark matter searches^{*}

KANG Ke-Jun(康克军)¹ YUE Qian(岳骞)^{1;1)} WU Yu-Cheng(吴昱城)¹ CHENG Jian-Ping(程建平)¹
 LI Yuan-Jing(李元景)¹ BAI Yang(白杨)³ BI Yong(毕勇)⁵ CHANG Jian-Ping(常建平)⁴
 CHEN Nan(陈楠)¹ CHEN Ning(陈宁)¹ CHEN Qing-Hao(陈庆豪)¹ CHEN Yun-Hua(陈云华)⁶
 CHUANG Yo-Chun(庄又澄)^{7;2)} DENG Zhi(邓智)¹ DU Qiang(杜强)¹ GONG Hui(宫辉)¹
 HAO Xi-Qing(郝喜庆)¹ HE Qing-Ju(何庆驹)¹ HU Xin-Hui(胡鑫洄)³ HUANG Han-Xiong(黄瀚雄)²
 HUANG Teng-Rui(黄腾锐)^{7;2)} JIANG Hao(江灏)¹ LI Hau-Bin(李浩斌)^{7;2)} LI Jian-Min(李荐民)¹
 LI Jin(李金)¹ LI Jun(李军)⁴ LI Xia(李霞)² LI Xin-Ying(李新颖)³ LI Xue-Qian(李学潜)³
 LI Yu-Lan(李玉兰)¹ LIAO Heng-Yi(廖恒毅)^{7;2)} LIN Fong-Kay(林枫凯)^{7;2)} LIN Shin-Ted(林欣德)^{7;2)}
 LIU Shu-Kui(刘书魁)⁵ LÜ Lan-Chun(吕岚春)¹ MA Hao(马豪)¹ MAO Shao-Ji(毛绍基)⁴
 QIN Jian-Qiang(覃建强)¹ REN Jie(任杰)² REN Jing(任婧)¹ RUAN Xi-Chao(阮锡超)²
 SHEN Man-Bin(申满斌)⁶ Lakhwinder SINGH^{7,8;2)} Manoj Kumar SINGH^{7,8;2)} Arun Kumar SOMA^{7,8;2)}
 SU Jian(苏健)¹ TANG Chang-Jian(唐昌建)⁵ TSENG Chao-Hsiung(曾昭雄)^{7;2)} WANG Ji-Min(王继敏)⁶
 WANG Li(王力)⁵ WANG Qing(王青)¹ WONG Tsz-King Henry(王子敬)^{7;2)} WU Shi-Yong(吴世勇)⁶
 WU Wei(吴蔚)³ WU Yu-Cheng(吴玉成)⁴ XING Hao-Yang(幸浩洋)⁵ XU Yin(徐音)³ XUE Tao(薛涛)¹
 YANG Li-Tao(杨丽桃)¹ YANG Song-Wei(杨松纬)^{7;2)} YI Nan(易难)¹ YU Chun-Xu(喻纯旭)³
 YU Hao(于昊)¹ YU Xun-Zhen(余训臻)⁵ ZENG Xiong-Hui(曾雄辉)⁶ ZENG Zhi(曾志)¹
 ZHANG Lan(张岚)⁴ ZHANG Yun-Hua(张蕴华)⁶ ZHAO Ming-Gang(赵明刚)³ ZHAO Wei(赵伟)¹
 ZHONG Su-Ning(钟苏宁)³ ZHOU Zu-Ying(周祖英)² ZHU Jing-Jun(朱敬军)⁵
 ZHU Wei-Bin(朱维彬)⁴ ZHU Xue-Zhou(朱学洲)¹ ZHU Zhong-Hua(朱忠华)⁶

(CDEX collaboration)

¹ Tsinghua University, Beijing 100084

² China Institute of Atomic Energy, Beijing 102413

³ Nankai University, Tianjin 300071

⁴ NUCTECH Company, Beijing 100084

⁵ Sichuan University, Chengdu 610065

⁶ YaLong River Hydropower Development Company, Chengdu 610051

⁷ Institute of Physics, AS, Taipei 11529

⁸ Department of Physics, Banaras Hindu University, Varanasi 221005

Abstract: The CDEX collaboration has been established for direct detection of light dark matter particles, using ultra-low energy threshold point-contact p-type germanium detectors, in China JinPing underground Laboratory (CJPL). The first 1 kg point-contact germanium detector with a sub-keV energy threshold has been tested in a passive shielding system located in CJPL. The outputs from both the point-contact P⁺ electrode and the outside N⁺ electrode make it possible to scan the lower energy range of less than 1 keV and at the same time to detect the higher energy range up to 3 MeV. The outputs from both P⁺ and N⁺ electrode may also provide a more powerful method for signal discrimination for dark matter experiment. Some key parameters, including energy resolution, dead time, decay times of internal X-rays, and system stability, have been tested and measured. The results show that the 1 kg point-contact germanium detector, together with its shielding system and electronics, can run smoothly with good performances. This detector system will be deployed for dark matter search experiments.

Key words: CDEX, point-contact germanium detector, dark matter, CJPL

PACS: 95.35.+d, 95.55.Vj **DOI:** 10.1088/1674-1137/37/12/126002

Received 31 January 2013, Revised 3 April 2013

^{*} Supported by National Natural Science Foundation of China (10935005, 10945002, 11275107, 11175099) and National Basic Research Program of China (973 Program) (2010CB833006)

1) Corresponding author. E-mail: yueq@mail.tsinghua.edu.cn

2) Participating as a member of the TEXONO collaboration

©2013 Chinese Physical Society and the Institute of High Energy Physics of the Chinese Academy of Sciences and the Institute of Modern Physics of the Chinese Academy of Sciences and IOP Publishing Ltd

1 Introduction

Light dark matter particles with masses of less than 10 GeV have become a new target for direct detection experiments. In order to search for dark matter Weakly Interacting Massive Particles (WIMP) in the low mass region, it is necessary to develop a detector system with an ultra-low energy threshold, as well as keeping its background level ultra-low. High Purity Germanium (HPGe) has been chosen as the target and detector for dark matter searches due to its very low radioactivity, very good energy resolution, ultra-low energy threshold and modular structure, which makes it easy to scale up to larger and larger masses of detector array while keeping almost the same performances as that of a small mass detector module. The China Dark matter Experiment (CDEX) Collaboration was established in 2009 to start a new program for searching for light dark matter, using ultra-low energy threshold germanium array detector systems. The physical goals and technical feasibility of the CDEX experiment were explored some time ago before the collaboration itself [1]. The first physics results for a dark matter search with an ultra-low energy threshold HPGe detector in a surface laboratory were published by the TEXONO collaboration [2], and are also partially based on such endeavors.

Other experiments, such as CoGeNT [3], XENON [4], CDMS [5], CRESST [6], DAMA [7] and so on, scan the low mass region for dark matter with different targets based on different technologies. The most stringent exclusive curve so far has been given by the XENON experiment in 2012. The WIMP-nucleon spin-independent cross-section is about 10^{-45} cm² at a WIMP mass of 50 GeV, but the sensitivity is still not good in the low mass region of less than 10 GeV [6], even though XENON's results have excluded the regions claimed by CoGeNT, DAMA and CRESST. The results from CoGeNT, DAMA and CRESST are also inconsistent with each other. All of these new results show us that the searching for dark matter particle WIMPs in the low mass region has become a topic of keen debate in recent years.

The CDEX collaboration will directly detect light dark matter particle WIMPs with masses of about 10 GeV using a tonne-scale germanium detector array composed of many 1 kg-scale PCGe (point-contact germanium) detectors. The energy threshold level and other performances of the tonne-scale detector should be almost the same, therefore, as that of a 1 kg-scale detector. A 1 kg-scale PCGe detector which can achieve an ultra-low energy threshold of less than 500 eV makes it powerful enough to scan the low mass region of dark matter. As a first step, the CDEX collaboration has studied a 1 kg PPCGe detector (CDEX-1).

2 China JinPing underground Laboratory

CJPL is located in the central part of a 17.5 km-long traffic tunnel which was built for the construction of hydropower plants on both sides of JinPing Mountain in Sichuan province, southwest China. The rock overburden in the central part of the traffic tunnel is about 2400 m (6720 m water equivalent depth). The construction of CJPL started in 2009 and the laboratory has been formally running since Dec. 2010. The current volume of CJPL is about 4000 m³ [8]. The cosmic-ray flux has been measured by triple-coincident scintillation counter telescopes and the muon flux measured to be about 60 muons y⁻¹·m⁻² [9]. This low flux is highly beneficial for dark matter searches and other rare event experiments in situ. Both the deep rock overburden to shield from cosmic-rays and the ambient rock with very low radioactivity make CJPL the best underground laboratory in the world for ultra-low background experiments such as dark matter, double beta decay and so on. It is also planned to further enlarge the space available at CJPL to host more experiments in the future.

3 The CDEX-1 detector system

The CDEX-1 detector system has been set up in a polyethylene room, which has 1 m thick walls inside in the China JinPing Laboratory, CJPL. The whole system consists of three parts: a 1 kg point-contact germanium detector; electronics and read out system; and a shielding system. This paper will describe the structure and performance of CDEX-1 in situ at CJPL.

3.1 1 kg-scale PPCGe detector

Germanium detector point-contact technology was developed several decades ago based on the general coaxial germanium detector technology [10]. In order to achieve an ultra-low energy threshold, the area of the germanium detector electrode should be as small as possible. We know that beside electronics noise the noise of a detector depends mainly on the capacitance of the detector. The capacitance of a detector is mainly related to the size of the electrode on the germanium detector. The electrode size of the contact point on a germanium detector can reach mm-scale and the corresponding capacitance can be ~ 1 pF. This point-contact technology provides the possibility to decrease the energy threshold of a germanium detector down to 500 eV or even lower.

Collaborating with Canberra Company, the CDEX collaboration has developed a p-type point-contact germanium (PPCGe) detector with a mass of 1 kg, which is the largest in the world so far. The structural materials of the 1 kg PPCGe detector, with ultra-low radioac-

tivity background, and its upgraded low noise pre-amp electronics give the detector a low radiation background and low noise qualities. The structure of the CDEX-1 PPCGe is shown in Fig. 1. The 1 kg PPCGe crystal is encapsulated within a 1.5 mm-thick Oxygen Free High Conductivity (OFHC) copper endcap. To suppress external low energy gamma rays (and X-rays), the endcap is windowless. The distance between the germanium crystal and the endcap is about 4 mm. The crystal cylinder has an n^+ type contact on the outer surface and a tiny p^+ type contact as the central electrode. The small diameter of the central electrode with the order of 1 mm reduces the capacitance of the detector to the order of 1 pF and greatly improves the intrinsic noise characteristics.

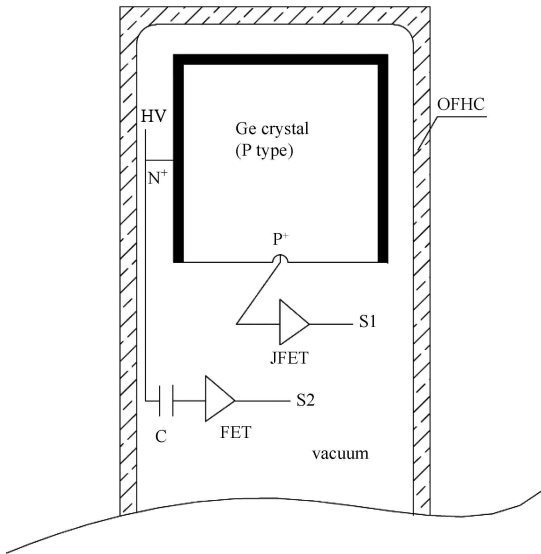

Fig. 1. The structure of CDEX-1 1 kg PPCGe detector.

3.2 The CDEX-1 electronics and read out system

The pre-amplifier outputs of the CDEX-1 1 kg PPCGe detector include the S1 signal from the point-contact P^+ electrode and S2 signal from the N^+ electrode which also served as the HV electrode. The p^+ point contact signal is read out by a pulsed optical feedback preamplifier with an ultra-low noise JFET nearby, and the signal from the n^+ type electrode is also read out by a resistive feedback preamplifier. Each pre-amplifier has 4 outputs: three identical OUT_E for energy measurement and one OUT_T for timing measurement which was not used for this experiment. The multiple outputs provide more choices to connect more main amplifiers with different shaping times and gains. All outputs should be well connected to the high impedance inputs of downstream modules. The detector is recommended to be operated under +3500 V high voltage.

The electronics and data acquisition system of the CDEX-1 1 kg PPCGe is illustrated simply in Fig. 2. All the NIM/VME modules and crates remain commercial products from Canberra [11] and CAEN [12] companies. In order to distinguish different pulse shapes, the signals from one output (OUT_E) of each preamplifier are amplified by a fast timing amplifier (Canberra 2111) and then fed into the flash analog-to-digital converter (FADC, CAEN V1724, 100 MHz sampling frequency) for fast pulse digital processing. The other preamplifier outputs are directly connected into a conventional spectroscopy amplifier (Canberra 2026) and then fed into the FADC for digitization. The signals from n^+ electrode are also fed into the FADC for digitization. One signal from the p^+ point contact electrode is discriminated after the spectroscopy amplifier and served as one of the triggers

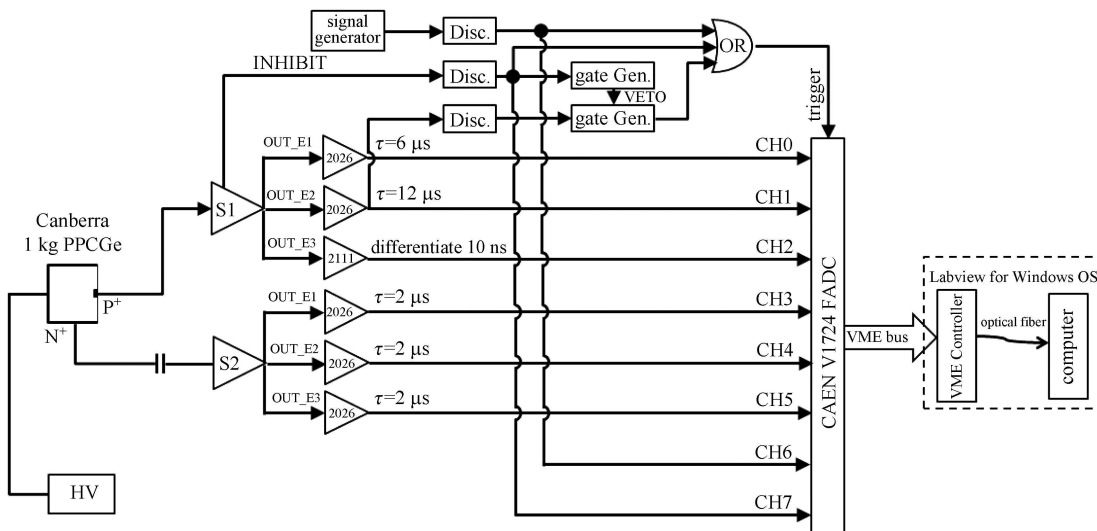

Fig. 2. The schematic electronic diagram of CDEX-1 1 kg PPCGe detector.

for the detector system. The random trigger signals at rate of 0.05 Hz from a pulse generator are used to measure the dead time of the electronics and read out system. All the data is transferred to a PC through a duplex optical fiber. The total trigger rate of the CDEX-1 1 kg PPCGe detector system is kept less than 10 Hz for long term data taking.

3.3 The shielding system

The CDEX-1 1 kg PPCGe detector was installed into CJPL in order to avoid background from cosmic-rays. A passive shielding system has been set up for shielding from gamma ray or neutron backgrounds from ambient rock and materials. The structure of the shielding system is shown in Fig. 3 and the materials from outside to inside are: 20 cm thick lead to shield from external gamma radiation from rock and other materials; and 20 cm thick boron-loaded polyethylene for neutron deceleration and thermal neutron absorption. The whole shielding system is located inside a 1 m thick layer of polyethylene for neutron shielding, which is not shown in Fig. 3. The CDEX-1 1 kg PPCGe detector was housed in the shielding system along with LN₂ Dewar. A 20 cm thick layer of OFHC copper surrounds the cryostat of the PPCGe detector to further decrease the residual gamma background from outside. The internal space between the 20 cm OFHC copper shielding and the cryostat was flushed with pure nitrogen gas to eliminate radioactive radon gas.

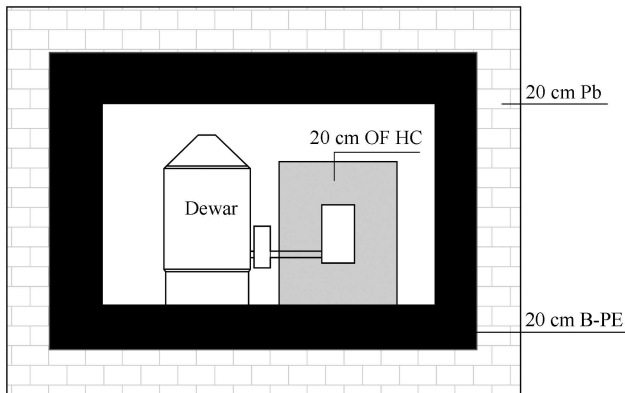

Fig. 3. The shielding system of CDEX-1.

4 The CDEX-1 1 kg PPCGe detector performances

The CDEX-1 1 kg PPCGe detector has been installed and thoroughly tested to achieve its optimal performances. Due to the 1.5 mm OFHC copper window, the 1 kg PPCGe detector could not be calibrated with external low-energy gamma or X-rays, as they cannot pass through the OFHC copper window. The studies of the detector performances have to be done using its

own internal characteristic X-ray lines in the low energy range.

The measured spectrum includes the 10.37 keV K shell X-ray from ⁷¹Ge and ⁶⁸Ge atoms, the 8.98 keV X-ray of ⁶⁵Zn atom and even 1.29 keV L shell X-ray from ⁷¹Ge and ⁶⁸Ge atoms. These internal characteristic X-ray lines can be used to calibrate the detector, monitor the stability of the detector system and study the energy resolution at different energy ranges. Many of the characteristic X-ray lines at the energy range of less than 12 keV are summarized in Table 1.

Table 1. The energies and lifetimes of K shell and L shell X-rays for different atoms.

atomic species	K-shell/keV	L-shell/keV	lifetime/day
⁷³ As	11.10	1.414	80.30
⁷¹ Ge	10.37	1.298	11.43
⁶⁸ Ge	10.37	1.298	270.8
⁶⁸ Ga	9.66	1.194	67.63
⁶⁵ Zn	8.98	1.096	244.3
⁵⁶ Ni	7.71	0.926	6.077
^{56,57,58} Co	7.11	0.846	77.27 ⁵⁶ , 271.8 ⁵⁷ , 70.86 ⁵⁸ ,
⁵⁵ Fe	6.54	0.769	997.1
⁵⁴ Mn	5.99	0.695	312.3
⁵¹ Cr	5.46	0.628	27.70
⁴⁹ V	4.97	0.564	330

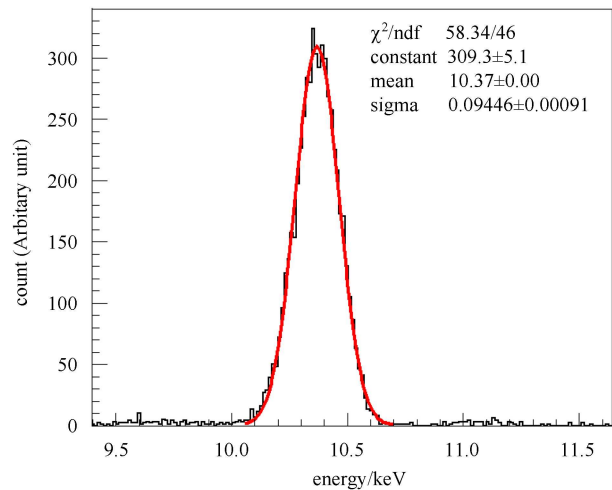

Fig. 4. 10.37 keV K shell X-ray peak of ^{68,71}Ge and the energy resolution fitting result.

4.1 Energy calibration

As illustrated in Fig. 2, different gains and shaping times are chosen to process the pre-amplifier signals. The channels from S1 have been set to only cover the low energy range below 12 keV and they can only be calibrated

by the intrinsic characteristic X-ray lines of the radioactive nuclei and natural long-life cosmogenic radioactive nuclei. Meanwhile, the channels from S2 are used to trace the backgrounds in relatively higher energy regions. So the channels from S2 are calibrated by some radiation source samples, e.g. Europium in our cases. Many peaks are fitted to do the energy calibration and energy lin-

earity study. The 10.37 keV peak and its fit result are shown in Fig. 4 as a sample. The calibration results of different channels are displayed in Fig. 5, showing one channel from S1 and three channels from S2. The calibration information can be seen in Table 2. At the same time, the zero energy point can be defined with random trigger events.

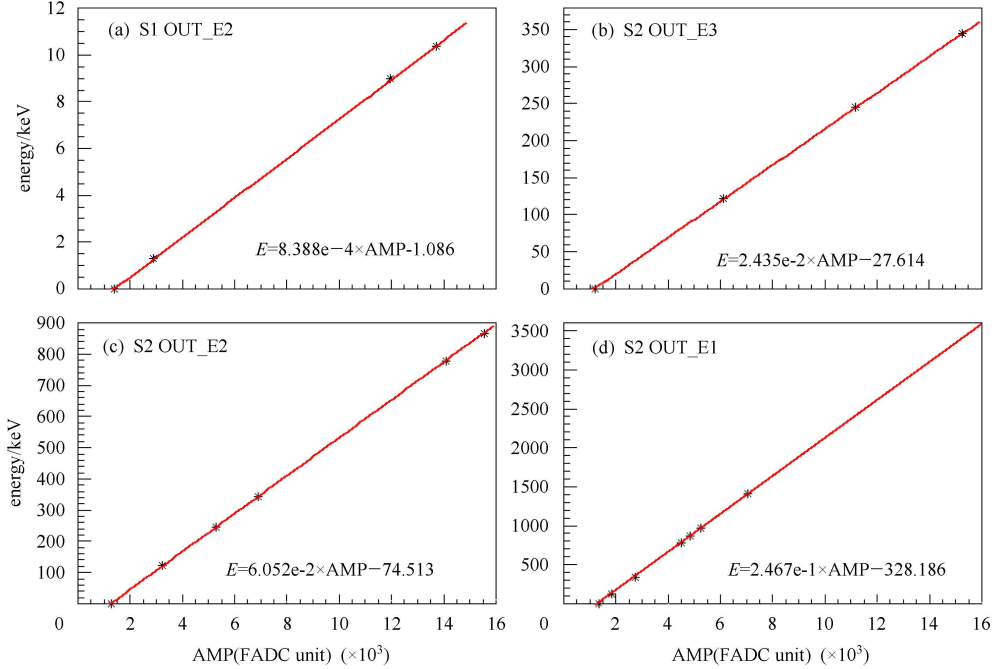

Fig. 5. Energy calibrations of CDEX-1 1 kg PPCGe detector including both S1 OUT_E2 channel (a) and three channels from S2 with different gains (b), (c), (d).

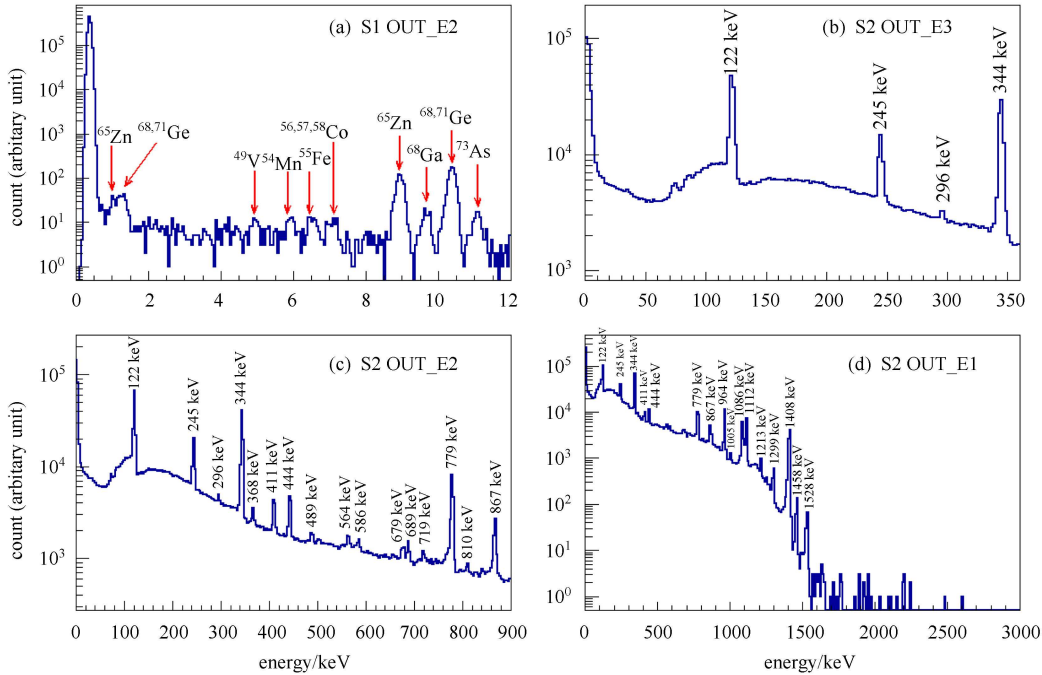

Fig. 6. Spectra associated with S1 channel (a) and the channels from S2 (b), (c), (d) with different gains.

Table 2. Selection of X-ray and gamma lines for calibration.

S1 OUT_E2			S2 OUT_E3		S2 OUT_E2		S2 OUT_E1	
background					source ^{152}Eu			
isotope	E/keV	FWHM/keV	E/keV	FWHM/keV	E/keV	FWHM/keV	E/keV	FWHM/keV
$^{68,71}\text{Ge}$ (X)	1.299	0.251	121.8	4.44	121.8	5.82	121.8	7.47
^{65}Zn (X)	8.979	0.212	244.7	4.81	244.7	7.02	344.3	6.39
$^{68,71}\text{Ge}$ (X)	10.37	0.222	344.3	4.19	344.3	5.34	778.9	8.04
—	—	—	—	—	778.9	6.39	867.4	9.60
—	—	—	—	—	867.8	7.52	964.1	7.65
—	—	—	—	—	—	—	1408	7.00

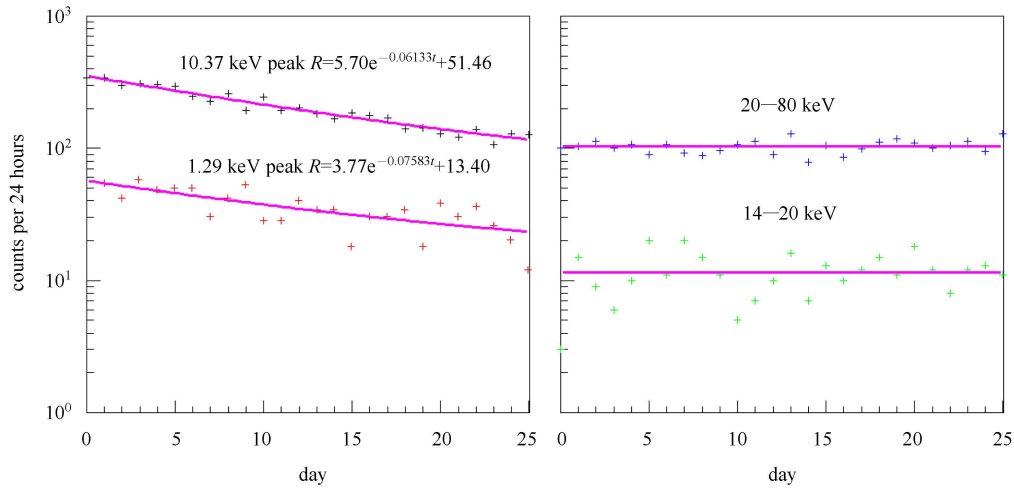

Fig. 7. Decays of characteristic X-rays associated with ^{71}Ge ($T_{1/2}=11.4$ d).

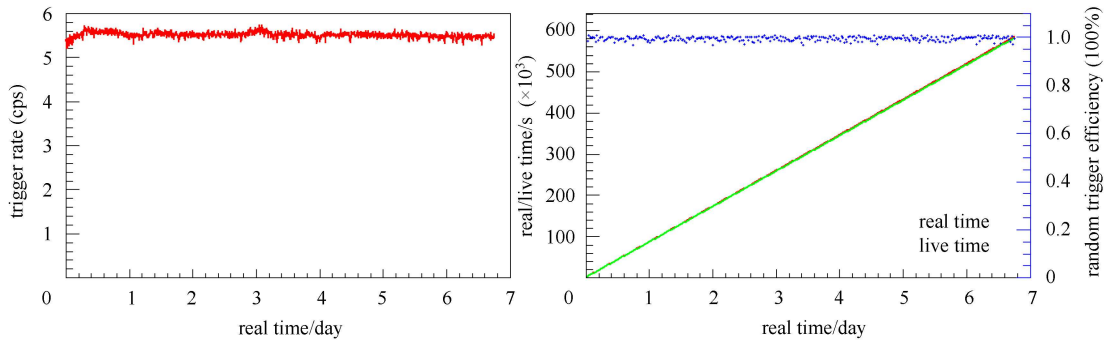

Fig. 8. Stability check of the CDEX-1 PPCGe detector.

4.2 Energy resolution

The measured energy spectra for calibration are shown in Fig. 6. Various characteristic X-ray and gamma lines can be clearly seen. The resolutions of different energy peaks are calculated and given in Table 2. After calibration, one can see from the spectra that there are many other characteristic X-ray peaks in the S1 OUT-E2 spectrum and that the energy threshold can be brought down to less than 1 keV without any electronic noise suppression. The X-ray peak from ^{65}Zn L shell can also be identified. So, we can see from the background spectrum

of S1 OUT_E2 that the detector has an ultra-low energy threshold and good energy resolution.

4.3 Decay of the low-energy characteristic X-rays

The characteristic X-rays observed in the low-energy spectrum from the point-contact electrode of the 1 kg PPCGe detector originate from the cosmogenic activation of the germanium crystal. After a long time of exposure to cosmic rays at ground level the intensities of these X-rays will achieve a balanced status. After the

germanium detector was moved into CJPL, the balanced status was broken and the number of radioactive nuclei decreased due to the lower production rate, which is related to the much lower muon flux inside CJPL. One can then measure the decays of some short life-time radioactive nuclei. Fig. 7 shows the decays of the 10.37 keV K-shell EC X-ray (KX-ray) peak and the 1.29 keV L-shell EC X-ray peak (LX-ray) from ^{71}Ge and ^{68}Ge . Due to the relatively long half-life of ^{68}Ge , the decay is mainly induced by the ^{71}Ge isotope. The rate data is fitted with exponential decay plus a constant background. The decay times of the 10.37 keV peak (11.3 ± 0.9 d) and the 1.29 keV peak (11.8 ± 3.0 d) are coincident with the half-life of ^{71}Ge ($T_{1/2}=11.4$ d). At the same time, there are no clear decays for events in the 14–20 keV and 20–80 keV energy ranges, which are mainly due to long-lived radioactive isotopes and other backgrounds.

4.4 Dead time

To calculate the real event rate, it is necessary to know the dead time of the data acquisition (DAQ) system of CDEX-1 1 kg PPCGe detector. One can see that in Fig. 2, there is a signal generator which contributes about 0.05 Hz to the total trigger rate of the CDEX-1 DAQ system. This periodic trigger can be considered as independent from the physical triggers from the 1 kg PPCGe detector and so can serve as random triggers. The dead time of CDEX-1 DAQ system can then be

calculated as the ratio of the unrecorded random trigger number and the generated random trigger number. Based on the data already collected the dead time of the CDEX-1 DAQ system is less than 1%.

4.5 Stability of the 1 kg PPCGe detector

To verify the validity of the data, several preliminary offline analyses were carried out, including trigger rate, random trigger efficiency and the ratio of real time to live time. In Fig. 8, one can see that the trigger rate and random trigger efficiency of the CDEX-1 DAQ are both relatively stable, showing that we can expect the whole experiment system to run smoothly and stably.

5 Summary

The CDEX collaboration has been established to search for dark matter particles with a tonne-scale mass germanium detector array system. As the first stage experiment, the CDEX collaboration has set up a point-contact germanium detector with a mass of 1 kg scale (CDEX-1) and studied the performance of the whole system in CJPL. The results show that the CDEX-1 detector system can run smoothly with good energy resolution and an ultralow energy threshold. For the next step this detector system will be used to directly search for dark matter particle WIMPs and we look forward to physics results being available soon.

References

- 1 YUE Qian, CHENG Jian-Ping, LI Yuan-Jing et al. HEP&NP, 2004, **28**(8): 877–880; HE Dao, LI Yu-Lan, YUE Qian et al. HEP & NP, 2004, **30**(6): 548–533; LI Xin, YUE Qian, LI Yuan-Jing et al. HEP & NP, 2007, **31**(6): 564–569 (in Chinese)
- 2 LIN Shin-Ted, LI Hau-Bin, LI Xin et al. Phys. Rev. D, 2009, **79**: 061101(R); LI Hau-Bin, LIAO Heng-Yi, LIN Shin-Ted et al. Phys. Rev. Lett., 2013, **110**: 261301
- 3 Aaleth C E et al. (CoGeNT collaboration). Phys. Rev. Lett., 2011, **107**: 141301
- 4 Aprile E et al. (XENON 100 collaboration). Phys. Rev. Lett., 2012, **109**: 181301
- 5 Ahmed Z et al. (CDMS collaboration). Phys. Rev. Lett., 2011, **106**: 131302
- 6 Angloher G et al. (CRESST collaboration). Eur. Phys. J. C, 2012, **72**: 1971
- 7 Bernabei R et al. (DAMA collaboration). Eur. Phys. J. C, 2010, **67**: 39; Belli P et al. Phys. Rev. D, 2011, **84**: 055014
- 8 KANG Ke-Jun, CHENG Jian-Ping, CHEN Yun-Hua et al. Journal of Physics: Conference Series, 2010, **203**: 012028; KANG Ke-Jun, CHENG Jian-Ping, LI Jin et al. Front. Phys., 2013, **8**: 412
- 9 WU Yu-Cheng, HAO Xi-Qing, YUE Qian et al. Measurement of Cosmic Ray Flux in China JinPing Underground Laboratory. Chin. Phys. C (HEP & NP), 2013, **37**(8): 086001
- 10 Luke P et al. IEEE Trans. Nucl. Sci., 1989, **36**: 926
- 11 www.canberra.com
- 12 www.caen.it