

# Design of Magnet System for RIKEN Superconducting ECR Ion Source

J. Ohnishi<sup>1)</sup> T. Nakagawa Y. Higurashi M. Kidera H. Saito A. Goto

(Nishina Cnter for Accelerator-based Science, RIKEN, Hirosawa 2-1, Wako, Saitama, 351-0198, Japan)

**Abstract** Superconducting magnet system for a 28GHz ECR ion source has been designed. The maximum axial magnetic fields are 4T at the rf injection side and 2T at the beam extraction side, respectively. The hexapole magnetic field is about 2T on the inner surface of the plasma chamber. The superconducting coils consist of six solenoids and six racetrack windings for a hexapole field. Two kinds of coil arrangements were investigated: one is an arrangement in which the hexpole coil is located in the bore of the solenoids, and another is the reverse of it. The coils use NbTi-Copper conductor and are bath-cooled in liquid helium. The six solenoids are excited with individual power supplies to search for the optimal axial field distribution. The current leads use high Tc material and the cryogenic system is operated in LHe re-condensation mode using small refrigerators. The thermal insulated supports of the cold mass have also been designed based on the calculated results of the magnetic force. The heat loads to 70K and LHe stages were estimated from the design of the supports, the current leads and so on.

**Key words** ECR ion source, superconducting coil, cryogenic system

## 1 Introduction

The RIKEN RI-beam factory project,<sup>[1]</sup> the commissioning of which is scheduled in December 2006, requires high intensity uranium beams. In the ion source, more than  $15\mu\text{A}$   $\text{U}^{35+}$  beam is requested as a final goal, therefore we have planned to develop a 28GHz superconducting ECR ion source.

Figure 1 shows the arrangement of the superconducting coil assembly for the 28GHz ECR ion source. The coils are composed of six solenoid coils SL1 to SL6 and a set of hexapole coils HX. Fig. 2 shows the mirror magnetic field along the axis. The peak fields at the rf injection side and the beam extraction side are 4T and 2T, respectively. The minimum magnetic field is changeable between 0 to 1T. The four solenoid coils SL2 to SL5 enable us to make a flat magnetic field in the central region. Fig. 2 also shows a usual

magnetic field distribution when SL3 and SL4 are not excited. The axial magnetic field can be optimized by changing the currents of SL2 to SL5.

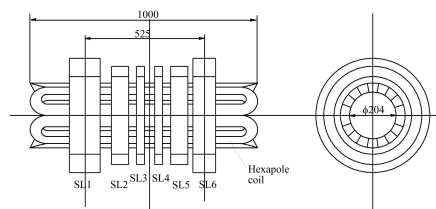

Fig. 1. Coil configuration of ECR ion source.

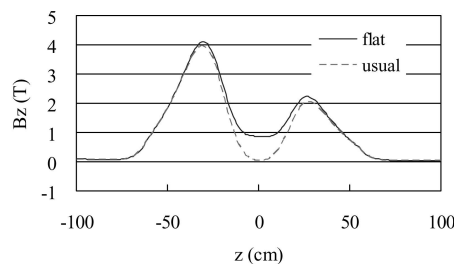

Fig. 2. Magnetic fields along the axis.

Received 20 April 2007

1) E-mail: ohnishi@postman.riken.go.jp

Figure 3 shows the magnetic field distributions on the surface of the plasma chamber with an inside radius of 75mm. The curve ‘By’ indicates a magnetic field produced by the hexapole coils and the curve ‘B’ the one including the axial field. Each hexpole coil has an iron pole<sup>[2]</sup> with a length of 300mm to strengthen the magnetic field at the central region, and the hexapole field of 2.1T at the maximum can be produced.

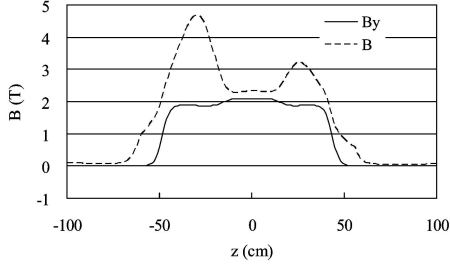

Fig. 3. Magnetic field on the surface of the plasma chamber.

## 2 Coil design

### 2.1 Arrangement in which the hexapole coils are located in the bore of the solenoids

Two kinds of coil arrangements<sup>[2, 3]</sup>, in which the hexapole coils are located in the bore of the solenoids and its reverse, have been investigated. This section describes the hexapole coils inside as shown in Fig. 1. The magnetic field distributions were already shown in Fig. 2 and Fig. 3. The coil dimensions and

parameters are given in Table 1. The inner radii of the hexapole and solenoid coils are 102mm and 170mm, respectively. The maximum field strengths in the coils are 7.5T for the solenoids and 6.9T for the hexapoles. The magnetic fields were calculated using 3d-code “TOSCA”. Each coil uses NbTi-Copper superconductor with a rectangular shape of 2mm×1mm. The copper/SC ratio is 1.5 for SL1 and the hexapole coil, and 4 for the other coils. The current margins  $I_c/I_{op}$  were calculated assuming that the critical current density  $J_c$  of NbTi is  $4720-450*B(T)$  (A/mm<sup>2</sup>). The magnetic stored energy is 830kJ when all coils are excited at the design current.

### 2.2 Arrangement in which the hexapole coils are located outside of the solenoids

Figure 4 shows a coil arrangement in which the hexapole coils are located outside of the solenoids. The inner radii of the plasma chamber, the solenoids and the hexapoles are 63mm, 85mm and 115mm, respectively. A cold yoke with a thickness of 170mm and an inner radius of 190mm are placed around the hexapole coils. Fig. 5 shows the axial magnetic field distribution (Hxout). The field distribution in the central region can also be changed by the four solenoid coils, and is not largely different from the case of the hexapole inside (Hxin) as shown in the figure. Table 2 gives the coil parameters. In this case, since the maximum magnetic field in the hexapole

Table 1. Coil dimensions and parameters for the configuration in which the hexapole coil is located in the bore of the solenoids.

	SL1	SL2	SL3	SL4	SL5	SL6	HX
inner radius/mm	170	170	170	170	170	170	102
outer radius/mm	250	215	215	215	215	250	142
length/mm	135	75	35	35	75	100	961
conductor size/mm	2.0×1.0	2.0×1.0	2.0×1.0	2.0×1.0	2.0×1.0	2.0×1.0	2.0×1.0
conductor size inc. insulation/mm	2.0×1.1	2.0×1.1	2.0×1.1	2.0×1.1	2.0×1.1	2.0×1.1	2.0×1.1
Cu/SC	1.5	4	4	4	4	4	1.5
No. turns	4464	1360	640	640	1360	3312	684
occupation factor	83%	81%	81%	81%	81%	83%	80%
current density/(A/mm <sup>2</sup> )	135	145	90	90	115	115	180
current/A	327	360	221	221	285	278	448
$B_{max}(max)/T$	7.5	5.0	4.0	4.0	4.7	5.5	6.9
$I_c/A$	1072	988	1168	1168	1042	898	1292
$I_c/I_{op}$	3.3	2.7	5.3	5.3	3.7	3.2	2.9
inductance/H	5.71	0.89	0.24	0.24	0.89	5.13	1.87
dump resistor/ $\Omega$	1.0	0.2	0.2	0.2	0.2	1.0	1.0

Table 2. Coil dimensions and parameters for the configuration in which the hexapole coil is located outside of the solenoids.

	SL1	SL2	SL3	SL4	SL5	SL6	HX
inner radius/mm	85	85	85	85	85	85	115
outer radius/mm	110	100	100	100	100	110	185
length/mm	160	30	30	30	30	100	680
No. turns	1672	182	182	182	182	1012	1280
current density/(A/mm <sup>2</sup> )	180	80	80	120	20	140	180
current/A	431	198	198	297	49	346	448
$B_{\max}(\max)/T$	6.9	6.5	5.9	5.9	6.1	6.2	7.1
$I_c/A$	1292	718	826	826	790	1544	1220
$I_c/I_{op}$	3.0	3.6	4.2	2.8	16.0	4.5	2.7
inductance/H	0.41	0.01	0.01	0.01	0.01	0.20	4.00
dump resistor/ $\Omega$	0.2	0.01	0.01	0.01	0.01	0.2	1.5

coil becomes high, it is necessary to keep the inner radius of the hexapole coils small and as a result the diameter of the plasma chamber is restricted to about 60–65mm.

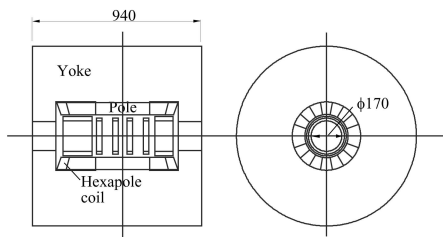

Fig. 4. Coil configuration in which the hexapole coil is located outside of the solenoids.

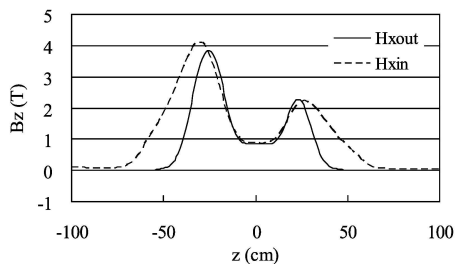

Fig. 5. Magnetic field along the axis for the two kinds of coil configurations.

### 3 Cryostat

Figure 6 shows a cross section of the cryostat in which the hexapole coils are placed in the bore of the solenoid coils. The superconducting solenoid and hexapole coils are located in a LHe vessel and cooled by the bath-cooling. The amount of the LHe is about 500L. The cryostat is equipped with two or three small refrigerators for the 4K and 70K stages and operated without supplying LHe after poured once.

The heat load to 4K is estimated to be 6W, which includes 3W due to X-ray irradiation from the plasma. A total of nine current leads made of high  $T_c$  material are used to reduce the heat load to 4K. The heat load to 70K is estimated to be 160W, which is caused by copper current leads, the supports of the cold mass and radiation through the multi-layer insulation. Magnetic shields with a thickness of 50mm surround the cryostat.

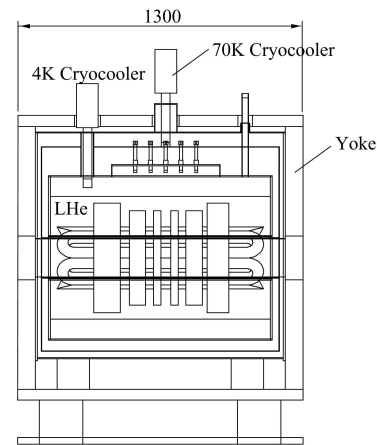

Fig. 6. Layout of the cryostat.

The electromagnetic force between the magnetic shields and the cold mass is estimated to be 80kN at the maximum in the axial direction when only the solenoid SL1 is excited. The cold mass is supported with GFRP belts from the outer tank at room temperature. Four belts with a cross-section of 300mm<sup>2</sup> are used for the axial direction to support the axial force of up to 100kN. On the other hand, eight belts with a cross-section of 80mm<sup>2</sup> are used for each of the vertical and horizontal directions to support the force of up to 50kN. Heat inputs to the 4K and 70K stages

through these supports are estimated to be 0.15W and 5.3W, respectively.

## 4 Quench protection

Figure 7 shows a connection diagram of electric circuit of the superconducting coils. The six solenoid coils and the hexapole coils are excited individually with seven power supplies. The solenoid coils are

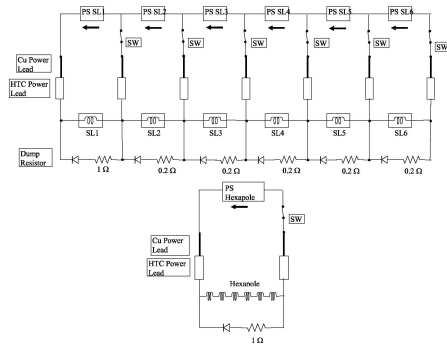

Fig. 7. Connection diagram of the superconducting coils and the power supplies.

excited through seven high  $T_c$  current leads. The current lead between two adjacent solenoids is used commonly to reduce the heat load. When a quench happens in any coil, all power supplies are disconnected from the coils and the stored energy is discharged to dump resistors. The resistances are designed to be  $1\Omega$  for SL1, SL6 and Hx and  $0.2\Omega$  for the others. The time constant for the coil SL1 is the longest; it is about 5s. The dump resistors and diodes are placed in the LHe vessel to protect the coils when any of the high  $T_c$  current leads breaks. Fig. 8 shows the calculated current waveforms in the fast dump when

all the coils are excited at the design current. In this calculation, the mutual inductances among the coils were considered but the resistance of normal zone of the quenched coil was not. The maximum voltages to the ground are 280V for SL1 and 450V for HX.

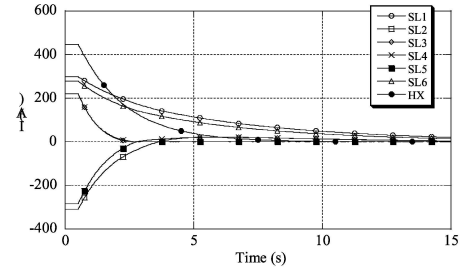

Fig. 8. Current waveforms of all the coils in the fast dump.

## 5 Conclusion

Basic design of the superconducting magnet system for a 28GHz ECR ion source has been studied. A coil arrangement in which the hexapole coils are located outside of the solenoids can be compact, but the diameter of a plasma chamber is restricted to about 60–65mm to get sufficient magnetic field strengths on its inner wall. Therefore, we have adopted an arrangement in which the hexapole coils are located inside of the solenoids, and studied not only the coils design but also the design of a cryostat and quench protection. We plan to manufacture it at an early date because it is indispensable to provide a highly-charged and high intensity uranium beam for the RI-beam factory project.

## References

- 1 Yano Y. Proc. 17th Int. Conf. on Cyclotrons and Their Applications, Tokyo, 2004. 169–173
- 2 Taylor C et al. IEEE Trans. Applied Superconductivity, 2000, **10**: 224
- 3 ZHAO H. Proc. 17th Int. Conf. on Cyclotrons and Their Applications, Tokyo, 2004. 269–271